

ANNEX A

PRICE INFORMATION SCHEDULES

SCHEDULE 1: PRICE SUMMARY AND TERMS OF PAYMENT

Tenderers shall set out in this Schedule:

1. **Price Summary** including the breakdown of the overall Tender Price stated in the Tender Form and any other terms of payment. The breakdown shall be detailed in the following format according to the summary of items and quantities required in the Tender. The price shall include any labour charges, custom tax and withholding tax.
2. Payment will be made locally and in Brunei Dollars. Payment shall be made in accordance with the provisions in the Contract.

ITEM	DESCRIPTION	QTY	UNIT PRICE B\$	TOTAL PRICE B\$
1.	Slip on D2P Blue - Laskar Muda (Lsm)	1090 PCS		
2.	Slip on D2P Blue - Laskar Kanan (Lsk)	610 PCS		
3.	Slip on D2P Blue - Bintara (Bint)	830 PCS		
4.	Slip on D2P Blue - Bintara Kanan (Bk)	330 PCS		
5.	Slip on D2P Blue - Pegawai Waran 2 (PW2)	260 PCS		
6.	Slip on D2P Blue - Pegawai Waran 1 (PW1)	180 PCS		
7.	Slip on D2P Blue - Pegawai Kadet	165 PCS		
8.	Slip on D2P Blue - Leftenan Madya (Lt Dya)	300 PCS		
9.	Slip on D2P Blue - Leftenan (Lt)	170 PCS		
10.	Slip on D2P Blue - Leftenan Komander (Lt Kom)	180 PCS		
11.	Slip on D2P Blue - Komander (Kom)	80 PCS		
12.	Slip on D2P Blue - Kepten (Kept)	20 PCS		
13.	Slip on D2P Blue - First Admiral (1 star)	5 PCS		



Ministry of Defence

Project Title: PEMBELIAN PANGKAT SLIP ON, EPAULETTE DAN PATCHES BAGI KEGUNAAN BAJU UNIFORM PEGAWAI DAN ANGGOTA TENTERA LAUT DIRAJA BRUNEI

Project Ref: MINDEF/DFA/FY2026/GCAU/TL/TA/6008

14.	Slip on D2P Blue - Admiral of the Fleet (5 stars)	5 PCS		
15.	Slip On Service Dress Rank - Officer Cadet	165 PRS		
16.	Slip On Service Dress Rank - Lieutenant Junior Grade	300 PRS		
17.	Slip On Service Dress Rank - Lieutenant RBN	170 PRS		
18.	Slip On Service Dress Rank - Lieutenant Commander	180 PRS		
19.	Slip On Service Dress Rank - Commander	80 PRS		
20.	Slip On Service Dress Rank - Captain RBN	10 PRS		
21.	Eppaulette Officer Cadet	165 PRS		
22.	Eppaulette Lieutenant Junior Grade	300 PRS		
23.	Eppaulette Lieutenant RBN	170 PRS		
24.	Eppaulette Lieutenant Commander	180 PRS		
25.	Eppaulette Commander	80 PRS		
26.	Eppaulette Captain RBN	10 PRS		
27.	Eppaulette First Admiral - 1 star	5 PRS		
28.	Eppaulette Admiral of the Fleet - 5 stars	5 PRS		
29.	Patches Laskar Muda (Lsm)	1090 PCS		
30.	Patches Laskar Kanan (Lsk)	610 PCS		



Ministry of Defence

Project Title: PEMBELIAN PANGKAT SLIP ON, EPAULETTE DAN PATCHES BAGI KEGUNAAN BAJU UNIFORM PEGAWAI DAN ANGGOTA TENTERA LAUT DIRAJA BRUNEI

Project Ref: MINDEF/DFA/FY2026/GCAU/TL/TA/6008

31.	Patches White Working Rig (WWR/WOD) Bintara (Bint)	830 PCS		
32.	Patches White Working Rig (WWR/WOD) Bintara Kanan (Bk)	330 PCS		
33.	Patches White Working Rig (WWR/WOD) Pegawai Waran 2 (PW2)	260 PCS		
34.	Patches White Working Rig (WWR/WOD) Pegawai Waran 1 (PW1)	180 PCS		
35.	Vocation Patch - Driver	90 PCS		
36.	Vocation Patch - Chef (paddy leaf)	130 PCS		
37.	Vocation Patch - Logistician	170 PCS		
38.	Vocation Patch - Steward	130 PCS		
39.	Vocation Patch - Base Defense	260 PCS		
40.	Vocation Patch - Clerk (Quill Pen)	100 PCS		
41.	Vocation Patch - Band	80 PCS		
42.	Vocation Patch - RP	190 PCS		
43.	Vocation Patch - PTI	50 PCS		
44.	Vocation Patch - Coxswain	70 PCS		
45.	Vocation Patch - Boatswain's Mate	70 PCS		
46.	Vocation Patch - Navigation	170 PCS		



Ministry of Defence

Project Title: PEMBELIAN PANGKAT SLIP ON, EPAULETTE DAN PATCHES BAGI KEGUNAAN BAJU UNIFORM PEGAWAI DAN ANGGOTA TENTERA LAUT DIRAJA BRUNEI

Project Ref: MINDEF/DFA/FY2026/GCAU/TL/TA/6008

47.	Vocation Patch - Communication	270 PCS		
48.	Vocation Patch - Electronic Warfare	270 PCS		
49.	Vocation Patch - Above Water Warfare	270 PCS		
50.	Vocation Patch - Above Water Tactical	270 PCS		
51.	Vocation Patch - Marine Technician	270 PCS		
52.	Vocation Patch - Weapon Technician	170 PCS		
53.	Vocation Patch - Navsag (Diving)	320 PCS		
TOTAL GRAND (B\$)				

NOTE:

- The Government reserves the right to give PARTIAL AWARD.
- The Government may accept the whole or any item (s) of tender.
- The Price quotes need to be maintained in items of partial award.
- **SPECIFICATION/SAMPELS/CATALOGUE MUST BE SUBMITTED AND CLEARLY LABELD.**
- Tender can visit and view our sample at the reception:

**DIRECTORATE OF FINANCE & ACQUISITION,
BLOCK D, GROUND FLOOR,
MINISTRY OF DEFENCE,
BOLKIAH GARISSON BB3510.**

**Monday – Thursday
0830 – 1100
1400 – 1530**

**Friday
0830 – 1030**



Ministry of Defence

Project Title: PEMBELIAN PANGKAT SLIP ON, EPAULETTE DAN PATCHES BAGI KEGUNAAN BAJU UNIFORM PEGAWAI DAN ANGGOTA TENTERA LAUT DIRAJA BRUNEI

Project Ref: MINDEF/DFA/FY2026/GCAU/TL/TA/6008

.ANNEX A – SPECIFICATION

ITEM 1 - 14	<p>'Slip on D2P Blue - Laskar Muda (Lsm) - 1090 PCS 'Slip on D2P Blue - Laskar Kanan (Lsk) - 610 PCS 'Slip on D2P Blue - Bintara (Bint) - 830 PCS 'Slip on D2P Blue - Bintara Kanan (Bk) - 330 PCS 'Slip on D2P Blue - Pegawai Waran 2 (PW2) - 260 PCS 'Slip on D2P Blue - Pegawai Waran 1 (PW1) - 180 PCS 'Slip on D2P Blue - Pegawai Kadet - 165 PCS 'Slip on D2P Blue - Leftenan Madya (Lt Dya) - 300 PCS 'Slip on D2P Blue - Leftenan (Lt) - 170 PCS 'Slip on D2P Blue - Leftenan Komander (Lt Kom) - 180 PCS 'Slip on D2P Blue - Komander (Kom) - 80 PCS 'Slip on D2P Blue - Kepten (Kept) - 20 PCS 'Slip on D2P Blue - First Admiral (1 star) - 5 PCS 'Slip on D2P Blue - Admiral of the Fleet (2 stars) - 5 PCS</p>
-------------	--

SLIP ON D2P SPECIFICATION

Ref	Description	Remarks
1	Colour	4 colour tone: 10% Blue 30% Dark Grey 40% Grey 20% Black 
2	Fabric	RBN Pixelated Camouflage Pattern Ripstop woven 100% Cotton (Fire retardant)

1. 'Slip on D2P Blue - Laskar Muda (Lsm)

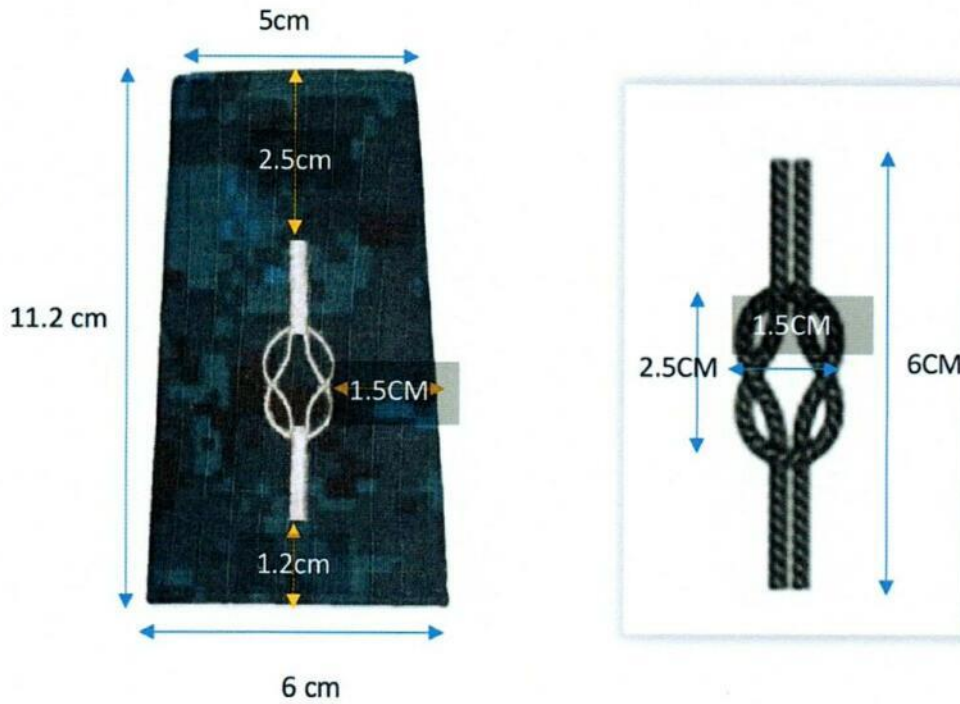

2. 'Slip on D2P Blue - Laskar Kanan (Lsk)

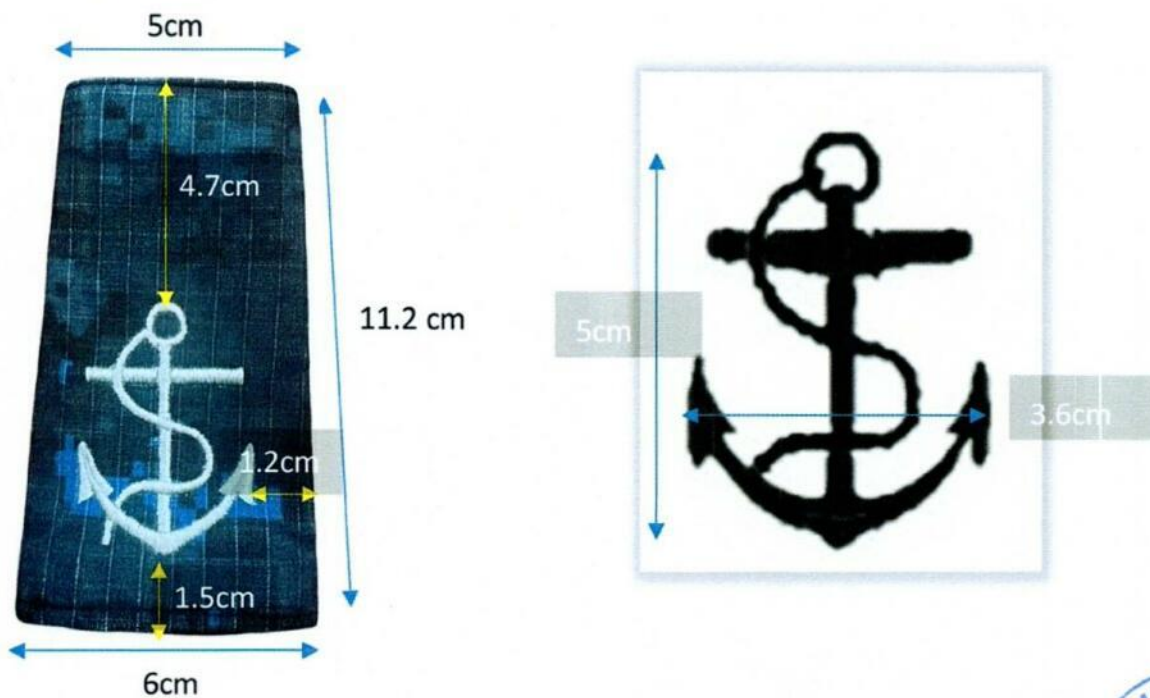

3. 'Slip on D2P Blue - Bintara (Bint)

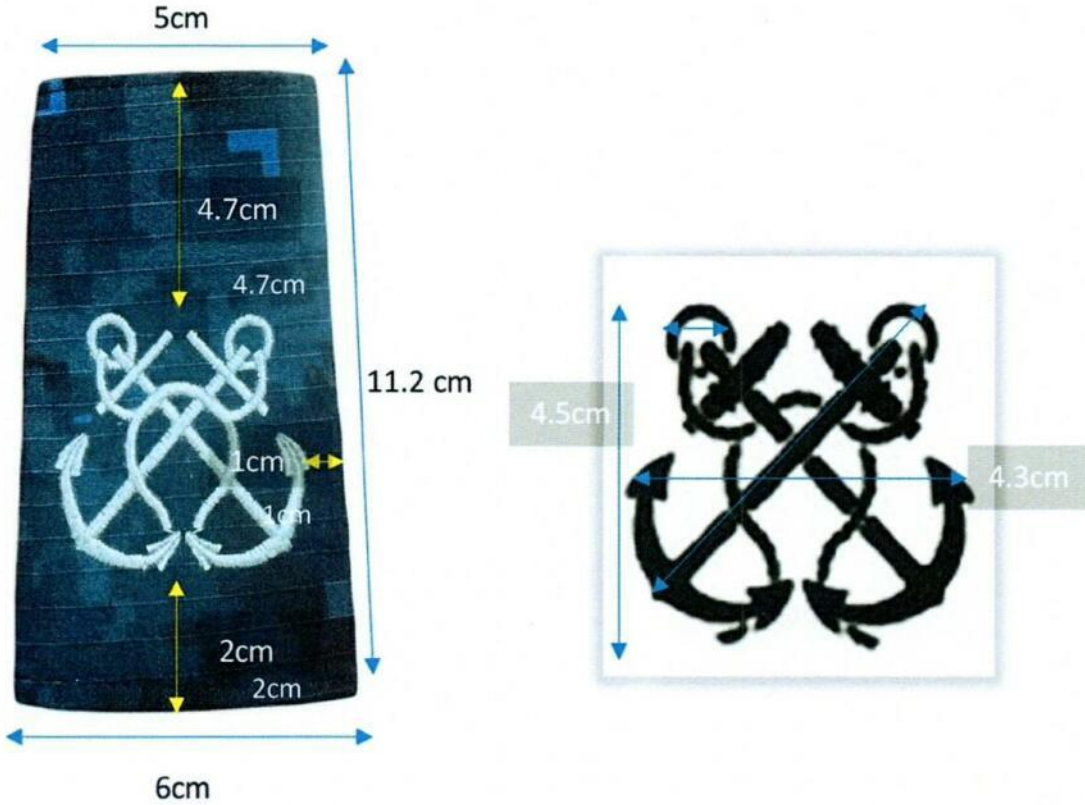

4. 'Slip on D2P Blue - Bintara Kanan (Bk)

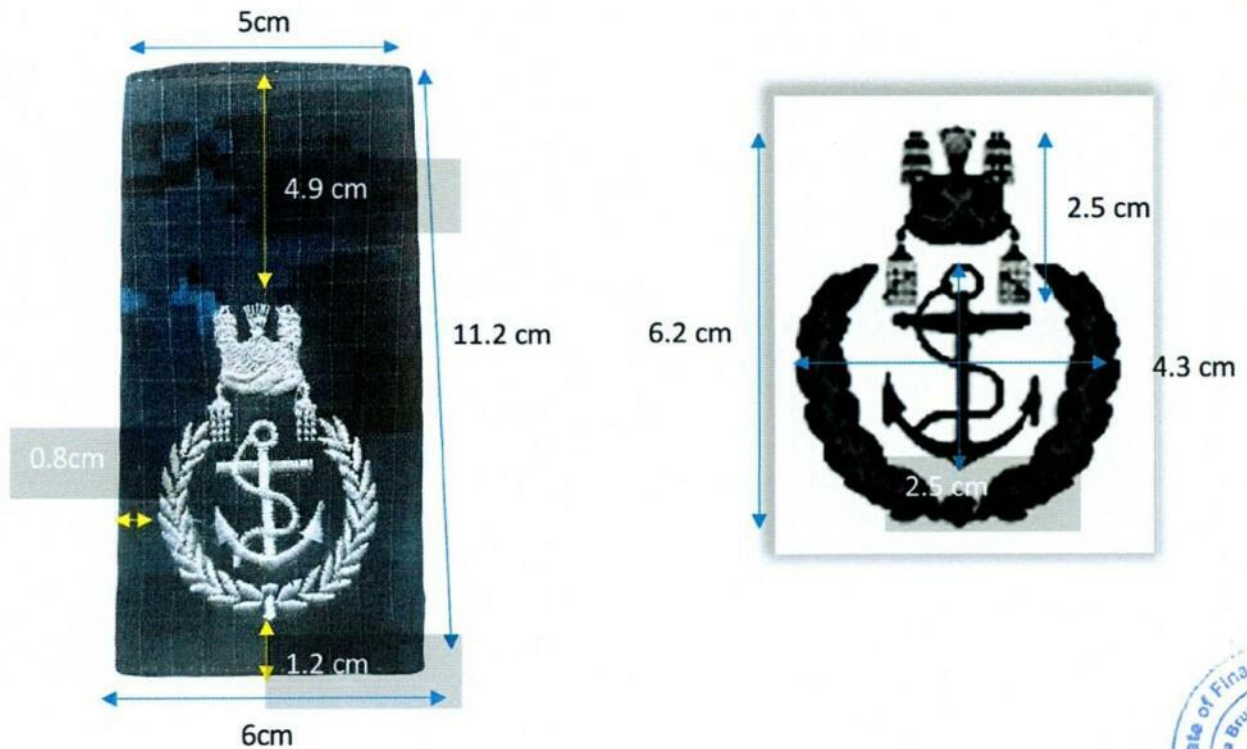

5. Slip on D2P Blue - Pegawai Waran 2 (PW2)

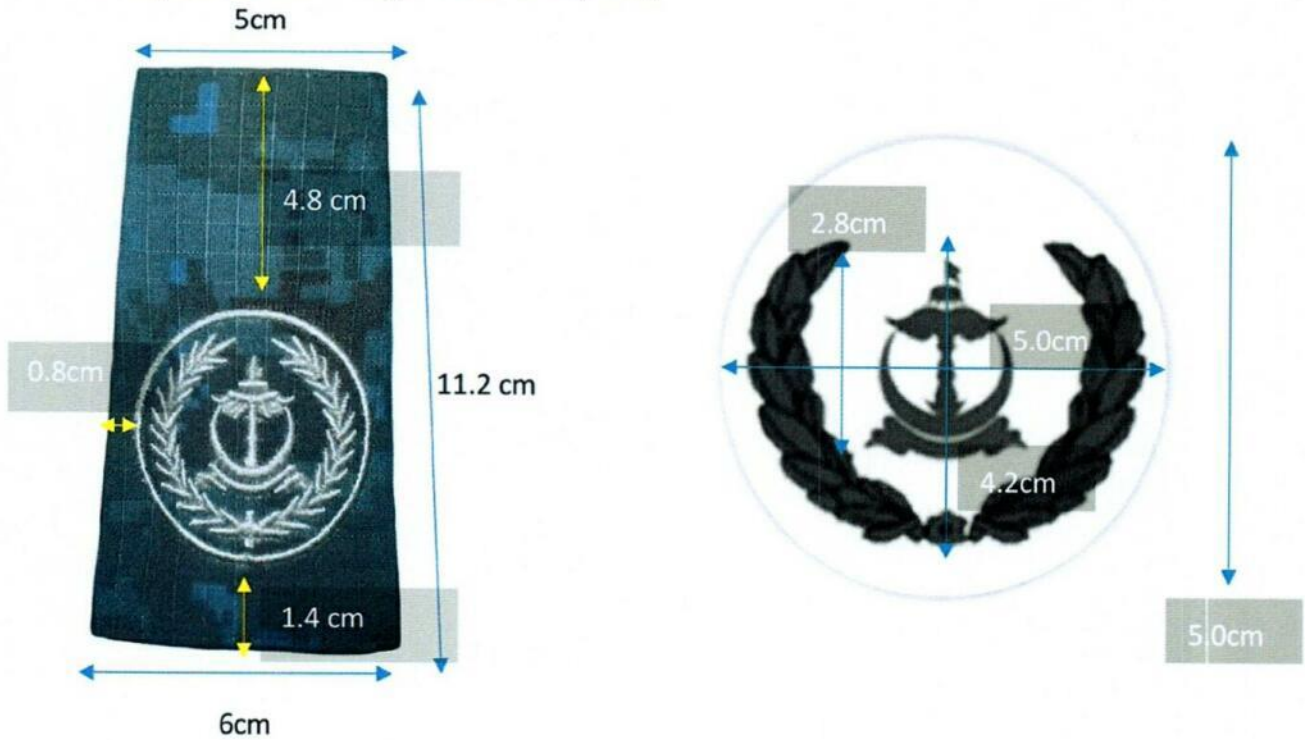

6. Slip on D2P Blue - Pegawai Waran 1 (PW1)

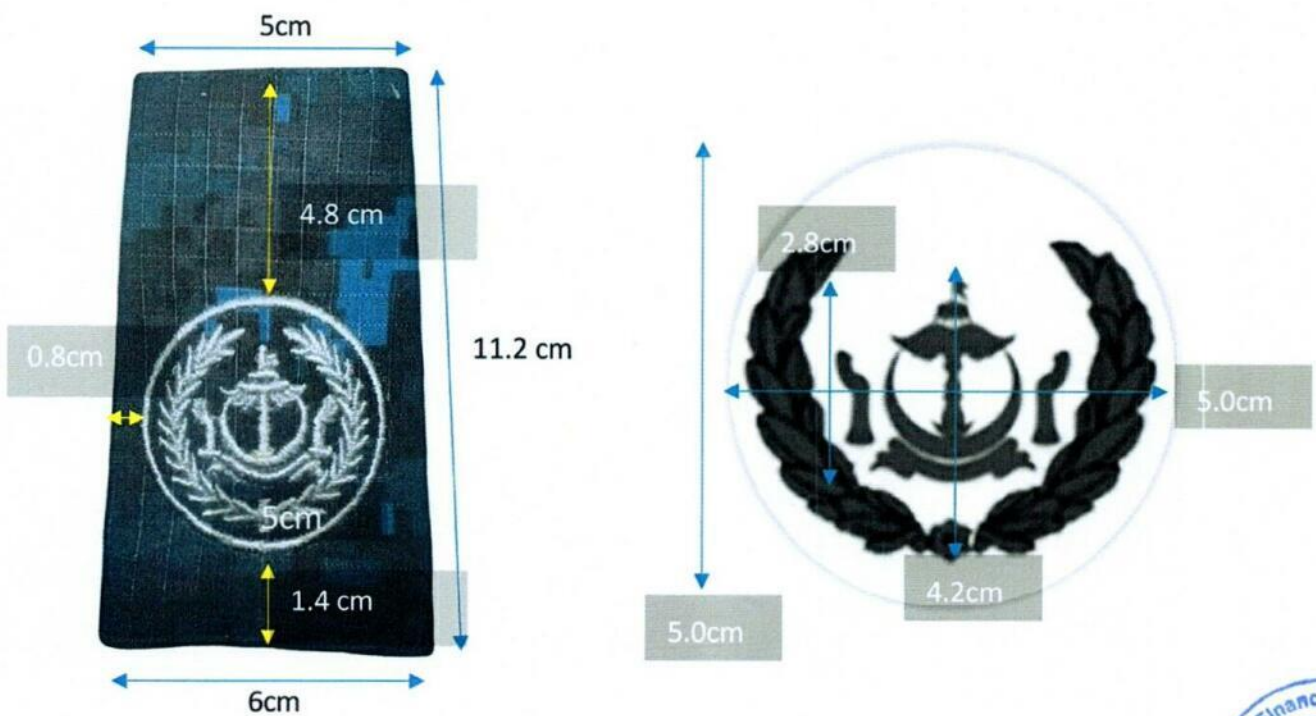

7. SLIP ON D2P BLUE – PEGAWAI KADET

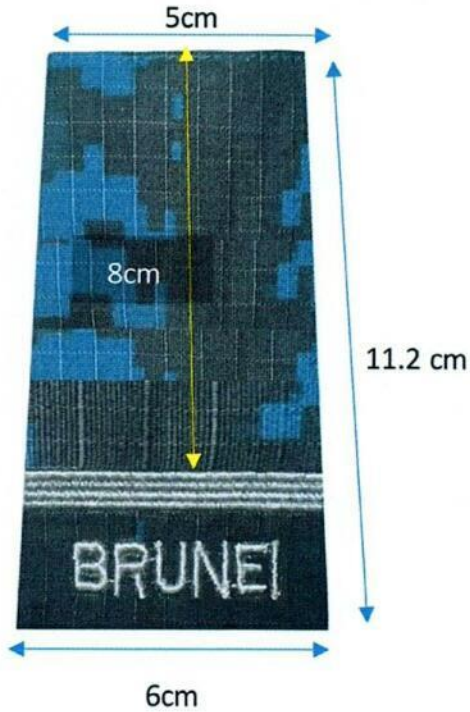

8. SLIP ON D2P BLUE – LEFTENAN MADYA

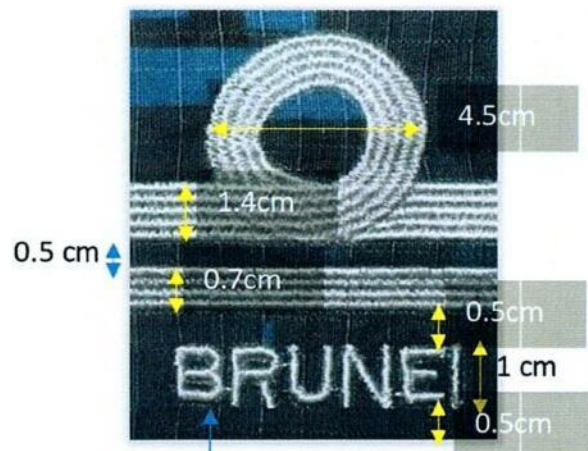

FONT: ARIAL REGULAR

9. SLIP ON D2P BLUE – LEFTENAN

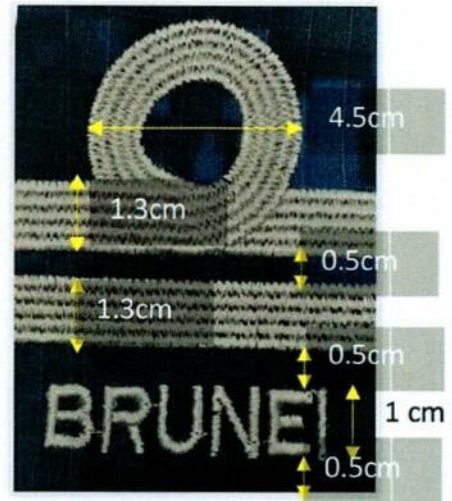

10. SLIP ON D2P BLUE – LEFTENAN KOMANDER

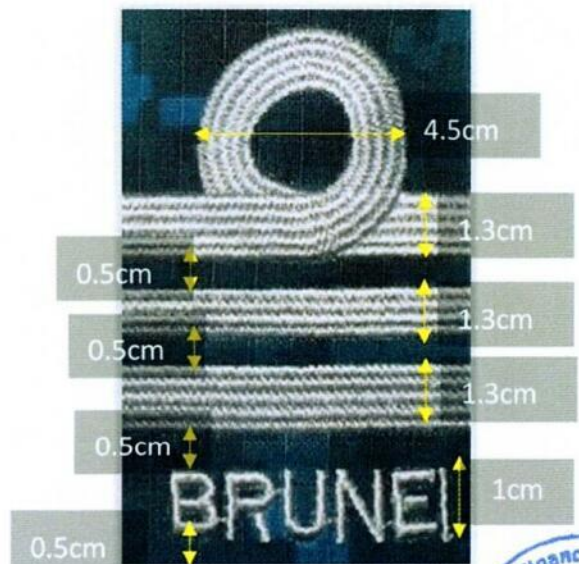

11. SLIP ON D2P BLUE – KOMANDER

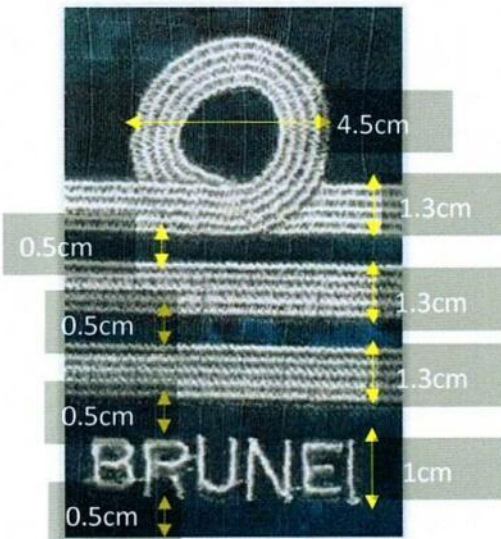

12. SLIP ON D2P BLUE – KAPTEN

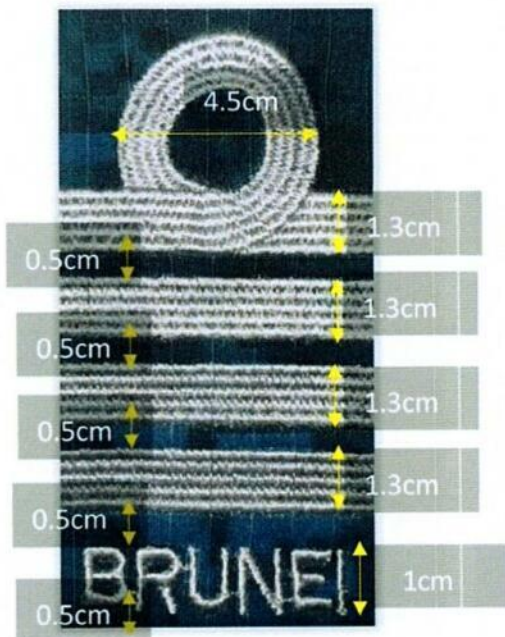

13. SLIP ON D2P BLUE – FIRST ADMIRAL

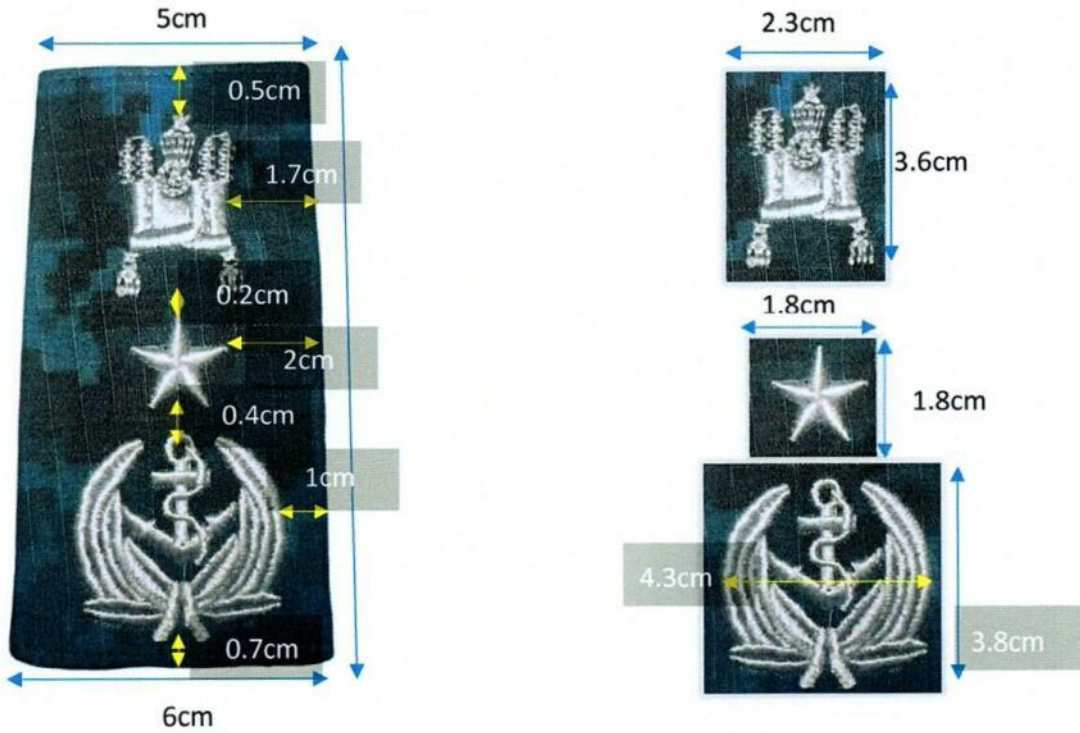

14. SLIP ON D2P BLUE – ADMIRAL OF THE FLEET

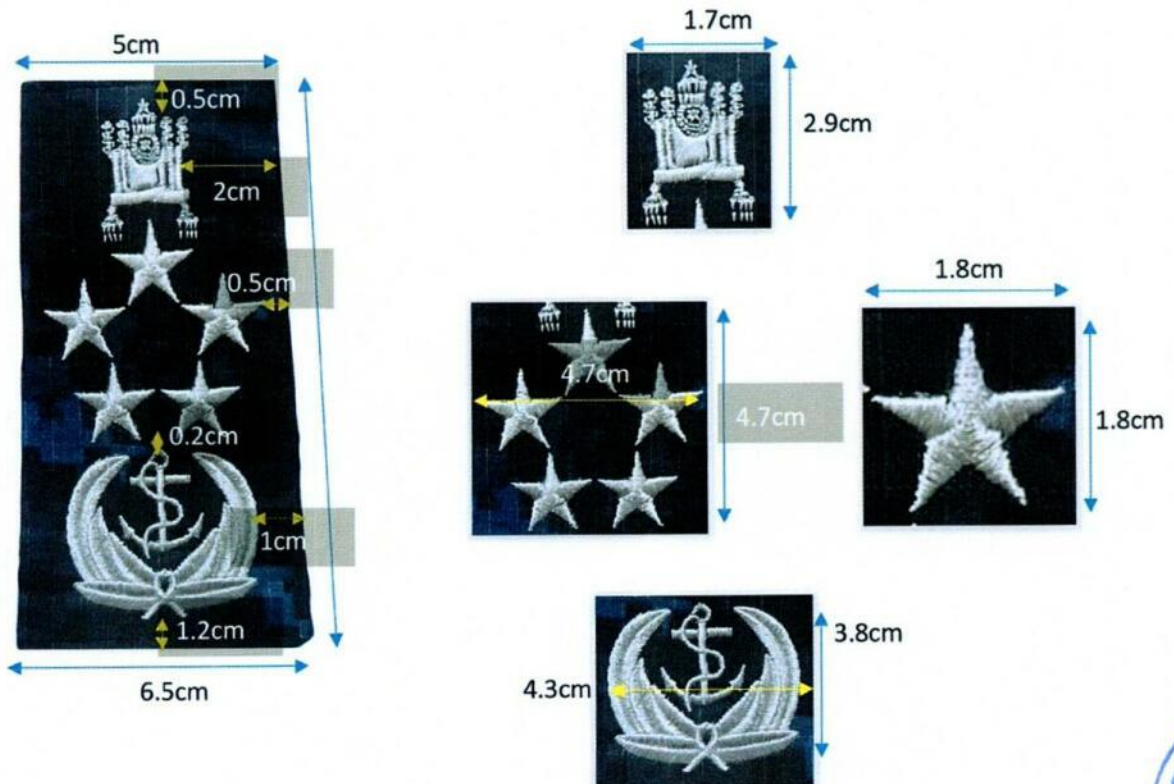

ITEM 16-20	Slip On Service Dress Rank Lieutenant Junior Grade- 300 PRS Slip On Service Dress Rank Lieutenant RBN -170 PRS Slip On Service Dress Rank Lieutenant Commander - 180 PRS Slip On Service Dress Rank Commander - 80 PRS Slip On Service Dress Rank Captain RBN - 10 PRS
-------------------	---

15. SLIP ON SERVICE DRESS RANK - OFFICER CADET

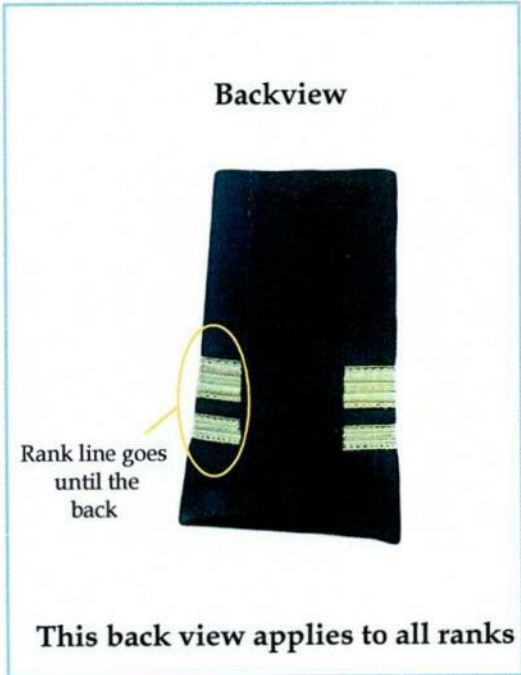

16. SLIP ON SERVICE DRESS RANK - LIEUTENANT JUNIOR GRADE



17. SLIP ON SERVICE DRESS RANK - LIEUTENANT RBN



18. SLIP ON SERVICE DRESS RANK - LIEUTENANT COMMANDER



Rank line Fabric: 100% polyester, Nylon twill
Line colour: Gold
Background colour: Black
Background fabric: plain velvet (Non shiny)
Font colour: Silver
Font name: ARIAL REGULAR

19. SLIP ON SERVICE DRESS RANK – COMMANDER

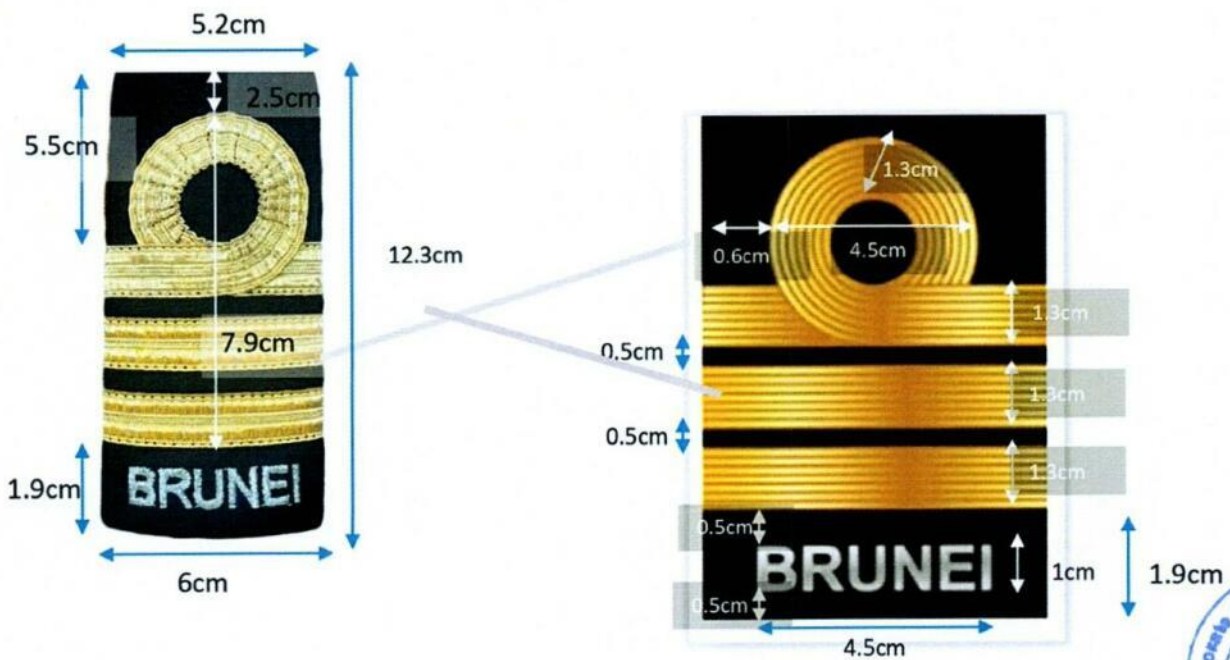

20. SLIP ON SERVICE DRESS RANK - CAPTAIN RBN



ITEM 21 - 28	<p>Eppaulette Officer Cadet - 165 PRS Eppaulette Lieutenant Junior Grade - 300 PRS Eppaulette Lieutenant RBN - 170 PRS Eppaulette Lieutenant Commander - 180 PRS Eppaulette Commander - 80 PRS Eppaulette Captain RBN - 10 PRS Eppaulette First Admiral 1 star - 5 PRS Eppaulette Admiral of the Fleet 5 stars - 5 PRS</p>
--------------	---

21. EPAULETTE OFFICER CADET

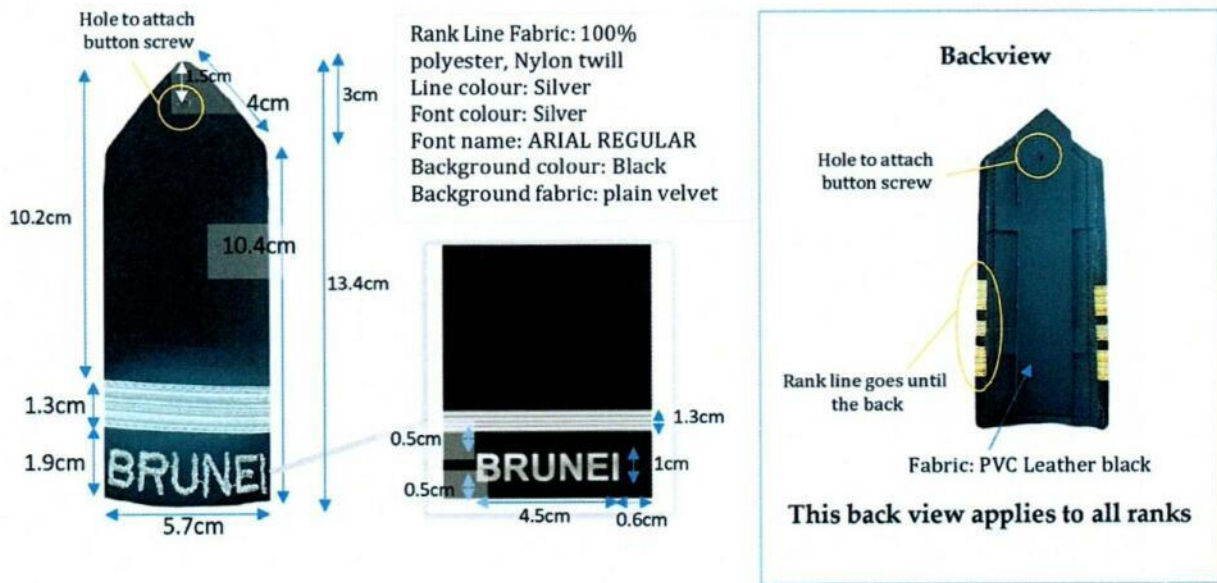

22. EPAULETTE LIEUTENANT JUNIOR GRADE



23. EPAULETTE LIEUTENANT RBN



24. EPAULETTE LIEUTENANT COMMANDER



25. EPAULETTE COMMANDER

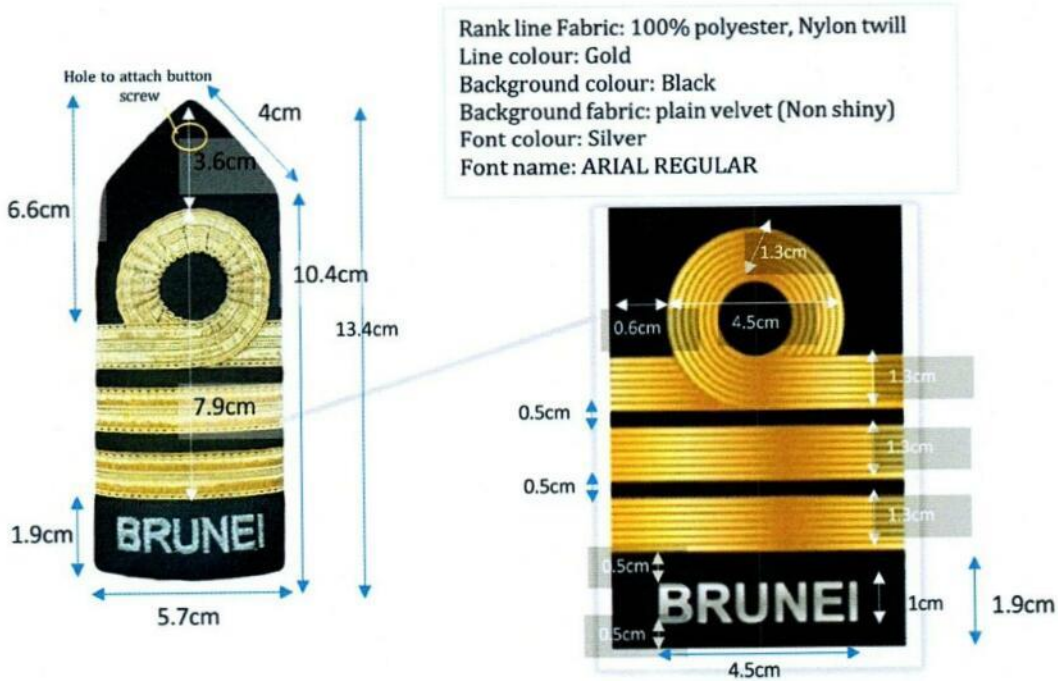

26. EPAULETTE CAPTAIN RBN

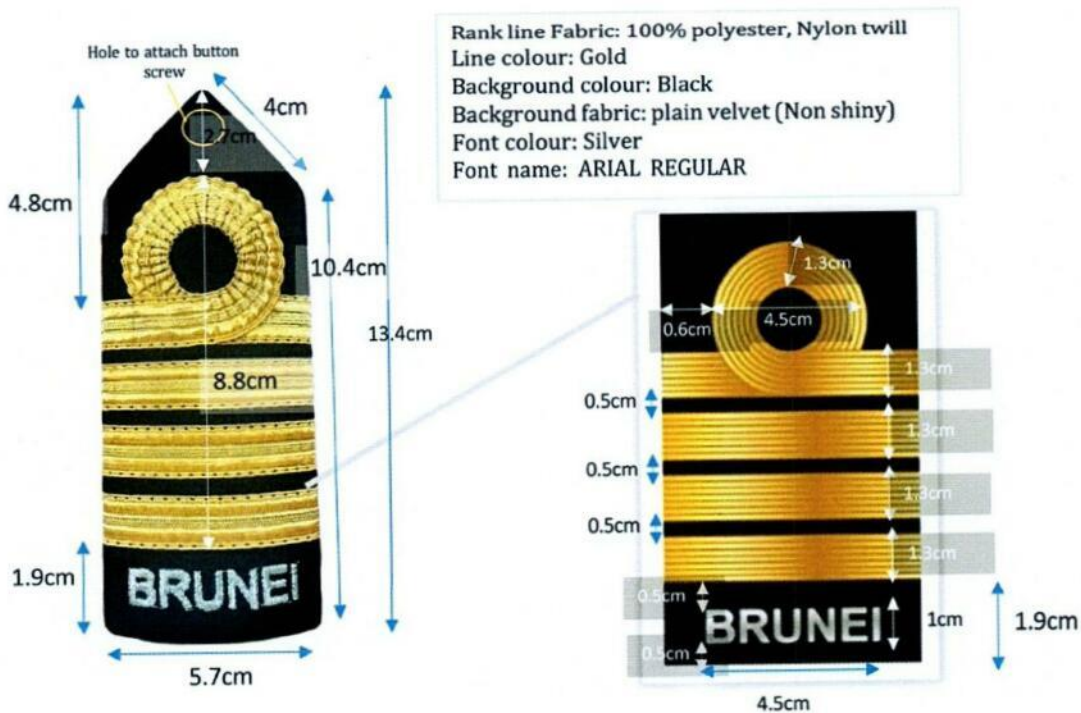

27. EPAULETTE FIRST ADMIRAL - 1 STAR

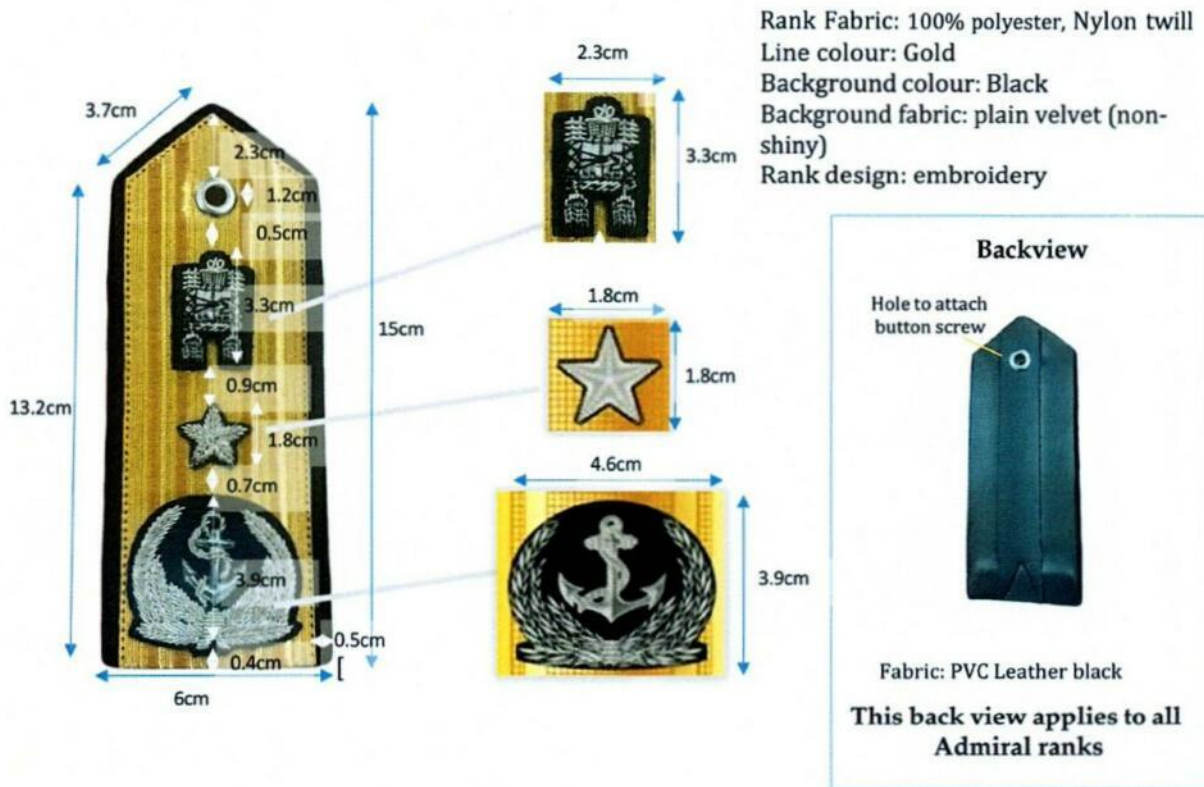

28. EPAULETTE ADMIRAL OF THE FLEET - 5 STARS

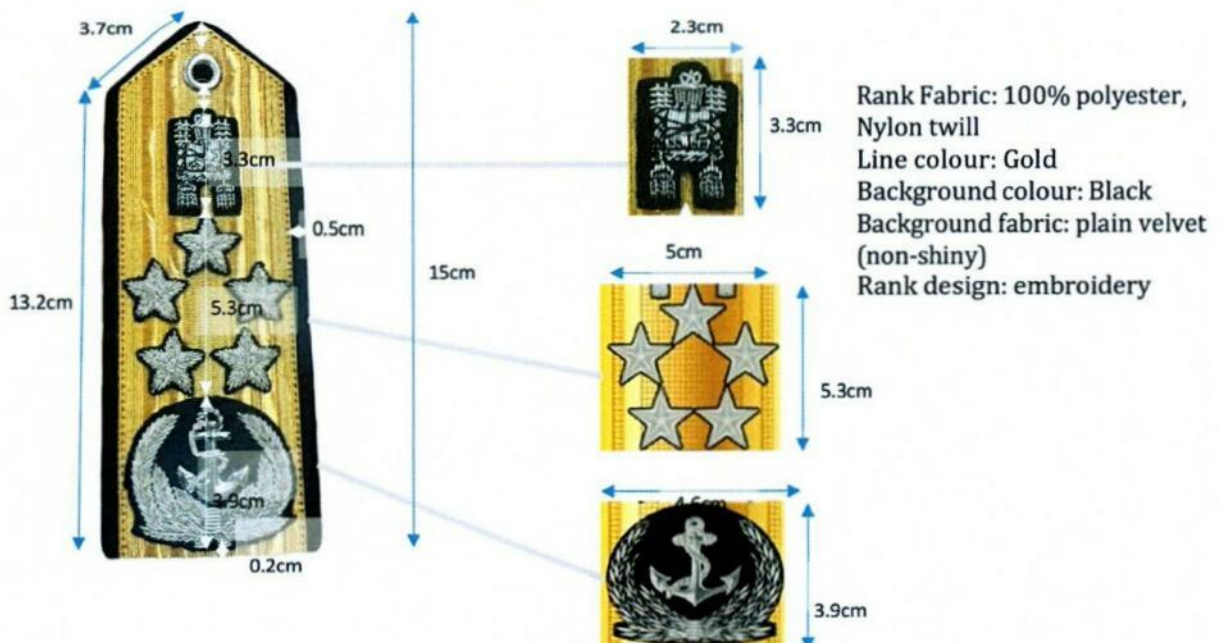

ITEM 29-34	<p>Patches Laskar Muda (Lsm) - 1090 PCS Patches Laskar Kanan (Lsk) - 610 PCS Patches White Working Rig (WWR/WOD) Bintara (Bint) - 830 PCS Patches White Working Rig (WWR/WOD) Bintara Kanan (Bk) - 330 PCS Patches White Working Rig (WWR/WOD) Pegawai Waran 2 (PW2)- 260 PCS Patches White Working Rig (WWR/WOD) Pegawai Waran 1 (PW1)- 180 PCS</p>
-------------------	---

29. PATCHES LASKAR MUDA (LSM)

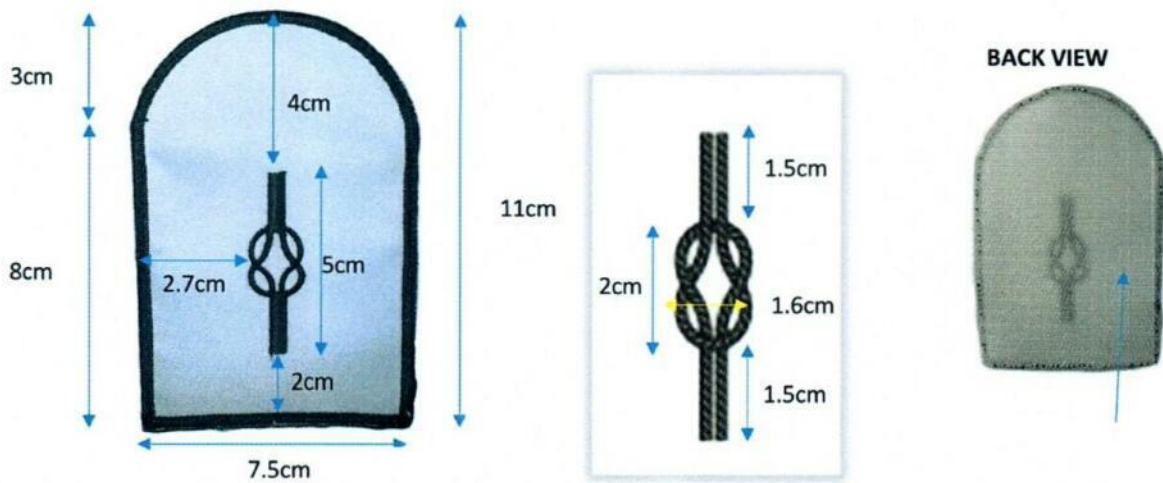

Border and patch design colour: black
 Background colour: offwhite
 Outside Border thickness: 0.3cm
 Fabric: 65% polyester, 35% ripstop

30. PATCHES LASKAR KANAN (LSK)

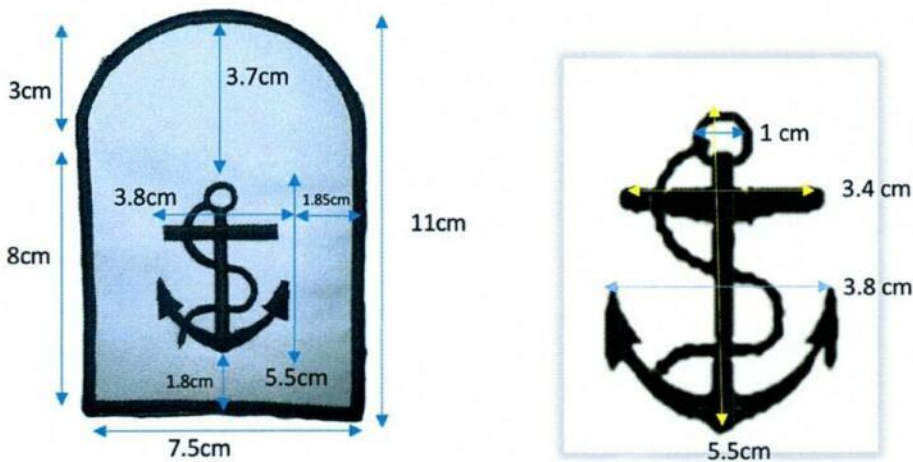

Border and patch design colour: black
 Background colour: offwhite
 Outside Border thickness: 0.3cm
 Fabric: 65% polyester, 35% ripsto



31. PATCHES WHITE WORKING RIG (WWR/WOD) BINTARA (BINT)

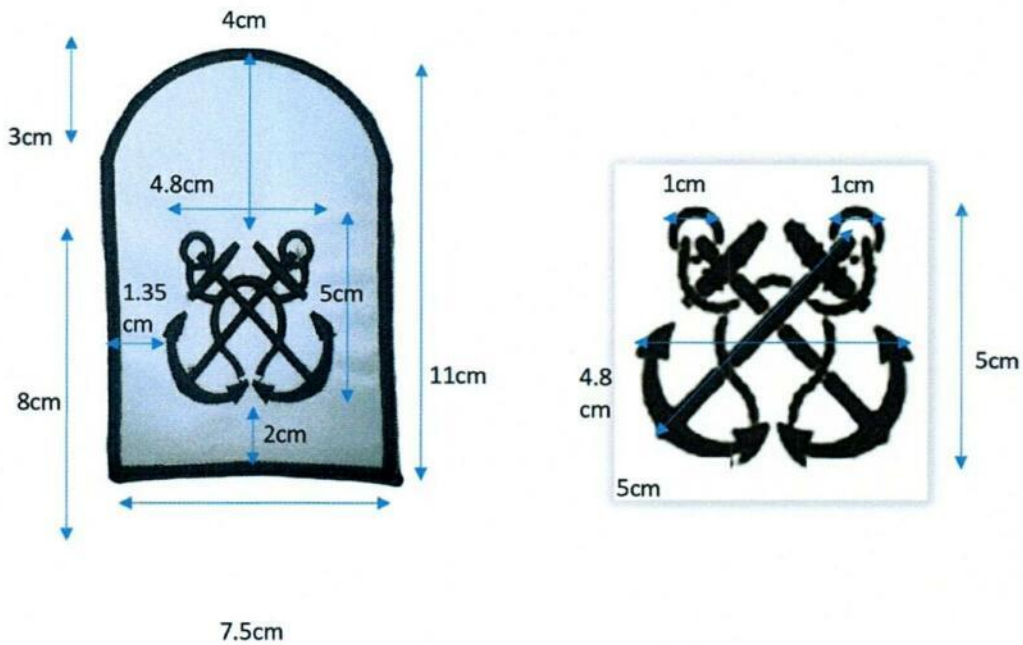

Border and patch design colour: black
Background colour: offwhite
Outside Border thickness: 0.3cm
Fabric: 65% polyester, 35% ripstop

32. PATCHES WHITE WORKING RIG (WWR/WOD) BINTARA KANAN (BK)

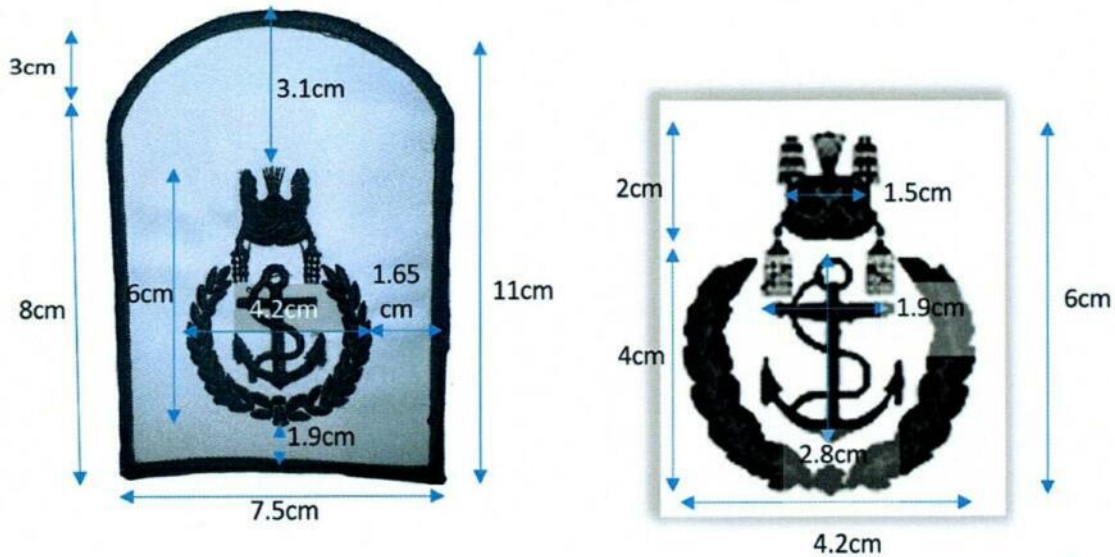

Border and patch design colour: black
Background colour: offwhite
Outside Border thickness: 0.3cm
Fabric: 65% polyester, 35% ripstop

33. PATCHES WHITE WORKING RIG (WWR/WOD) PEGAWAI WARAN 2 (PW2)

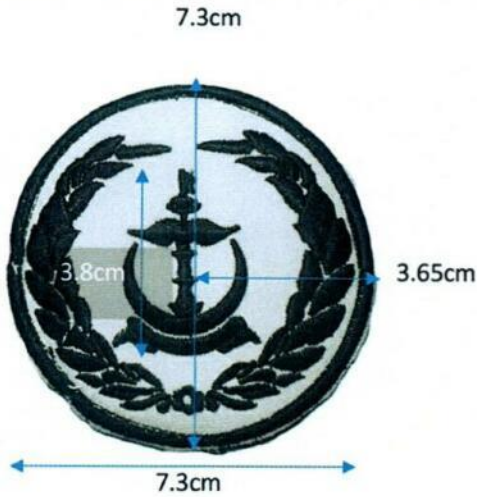

Border and patch design colour: black
Background colour: offwhite
Outside Border thickness: 0.3cm round border
Fabric: 65% polyester, 35% ripstop

34. PATCHES WHITE WORKING RIG (WWR/WOD) PEGAWAI WARAN 1 (PW1)

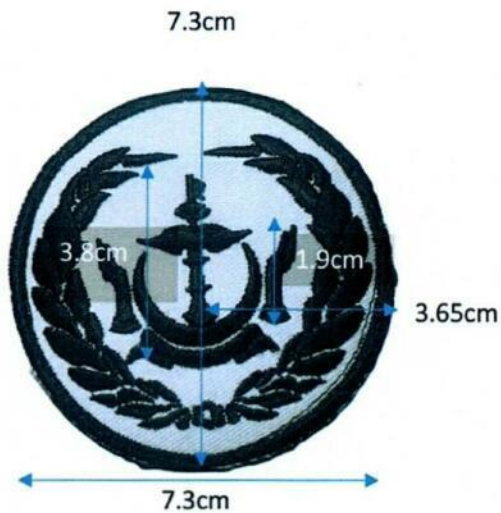

Border and patch design colour: black
Background colour: offwhite
Outside Border thickness: 0.3cm round border
Fabric: 65% polyester, 35% ripstop

ITEM 35 -53	<p>Vocation Patch - Driver - 90 PCS</p> <p>Vocation Patch - Chef (paddy leaf) - 130 PCS</p> <p>Vocation Patch - Logistician-170PCS</p> <p>Vocation Patch - Steward - 130 PCS</p> <p>Vocation Patch - Base Defense - 260 PCS</p> <p>Vocation Patch - Clerk (Quill Pen) - 100 PCS</p> <p>Vocation Patch - Band - 80 PCS</p> <p>Vocation Patch - RP - 190 PCS</p> <p>Vocation Patch - PTI - 50 PCS</p> <p>Vocation Patch - Coxswain 70 PCS</p> <p>Vocation Patch - Boatswain's Mate - 70 PCS</p> <p>Vocation Patch - Navigation - 170 PCS</p> <p>Vocation Patch - Communication - 270 PCS</p> <p>Vocation Patch - Electronic Warfare - 270 PCS</p> <p>Vocation Patch - Above Water Warfare - 270 PCS</p> <p>Vocation Patch - Above Water Tactical - 270 PCS</p> <p>Vocation Patch - Marine Technician - 270 PCS</p> <p>Vocation Patch - Weapon Technician - 170 PCS</p> <p>Vocation Patch - Navsag (Diving) - 320 PCS</p>
-------------	--

35. VOCATION PATCH – DRIVER

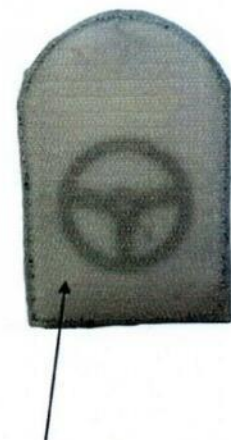
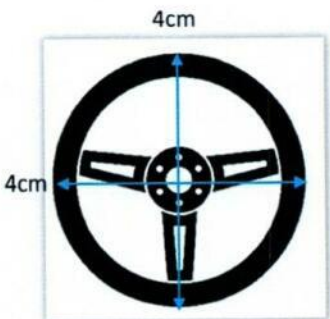
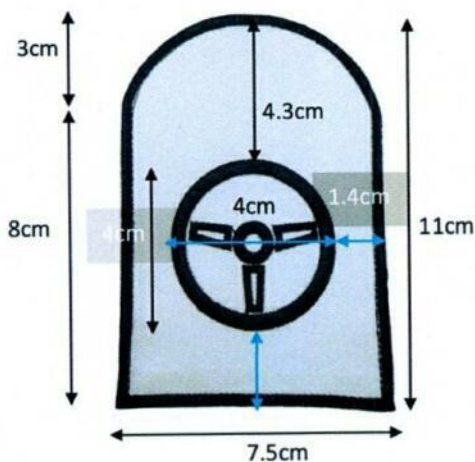

Note: given altogether with white velcro patch at the back.
This applies to all patches

Border and patch design colour: black
Background colour: offwhite
Outside Border thickness: 0.3cm
Fabric: 65% polyester, 35% ripstop



36. VOCATION PATCH - CHEF (PADDY LEAF)

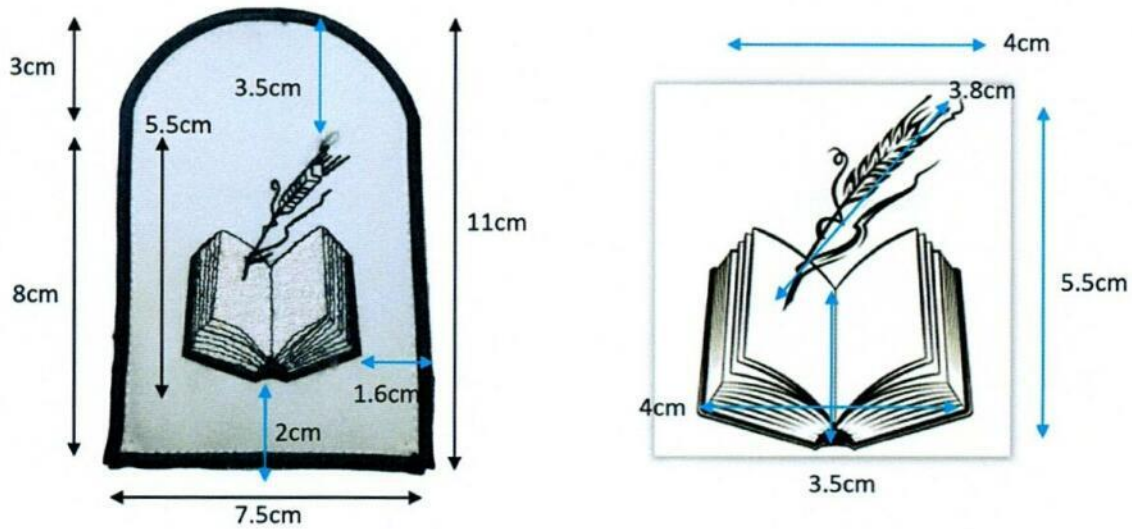

Border and patch design colour: black
Background colour: offwhite
Outside Border thickness: 0.3cm
Fabric: 65% polyester, 35% ripstop

37. VOCATION PATCH – LOGISTICIAN

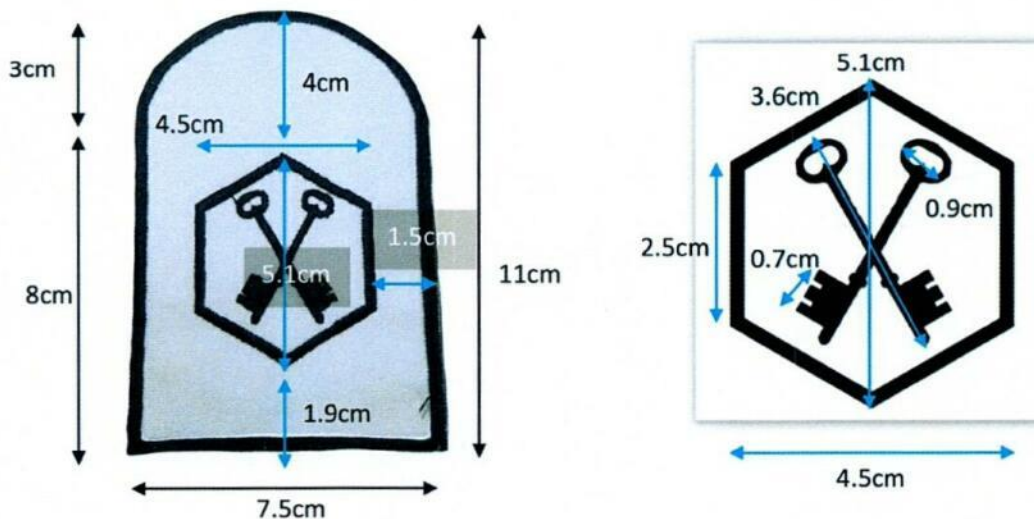

Border and patch design colour: black
Background colour: offwhite
Outside Border thickness: 0.3cm
Fabric: 65% polyester, 35% ripstop

38. VOCATION PATCH – STEWARD

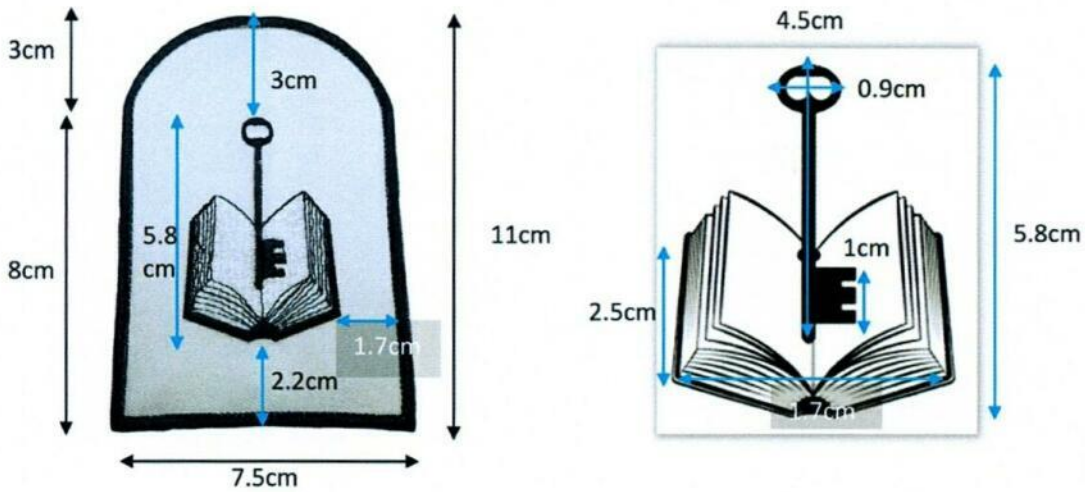

Border and patch design colour: black
Background colour: offwhite
Outside Border thickness: 0.3cm
Fabric: 65% polyester, 35% ripstop

39. VOCATION PATCH - BASE DEFENSE



Border and patch design colour: black
Background colour: offwhite
Outside Border thickness: 0.3cm
Fabric: 65% polyester, 35% ripstop

40. VOCATION PATCH - CLERK (QUILL PEN)

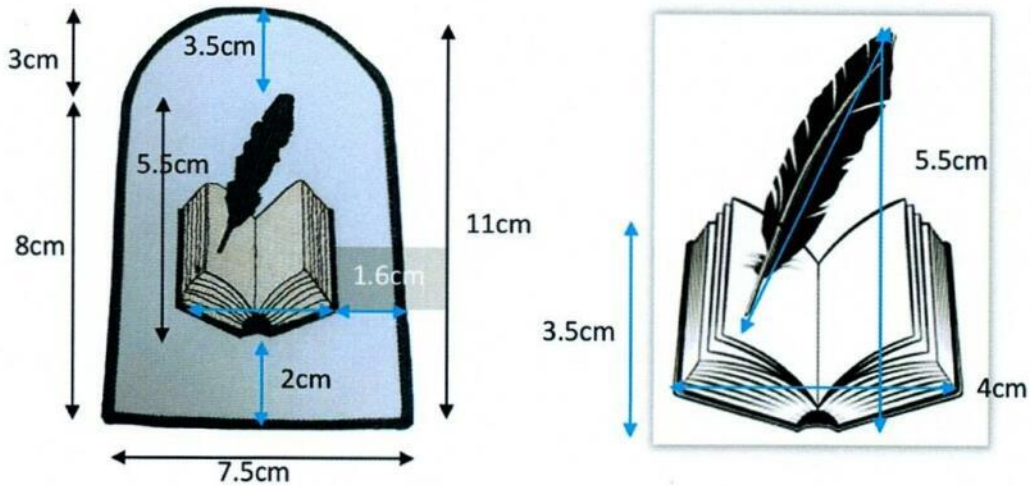

Border and patch design colour: black
Background colour: offwhite
Outside Border thickness: 0.3cm
Fabric: 65% polyester, 35% ripstop

41. VOCATION PATCH – BAND

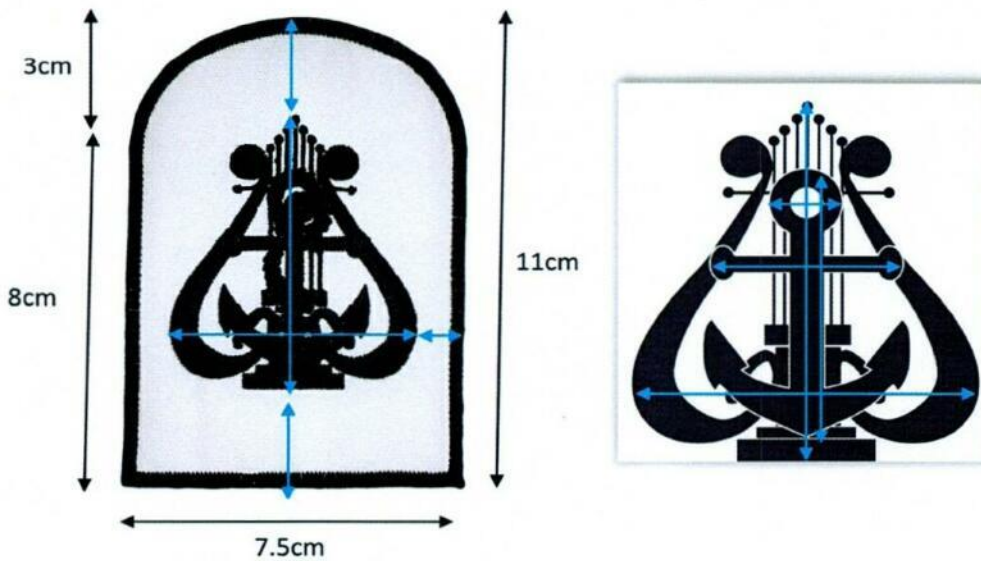

Border and patch design colour: black
Background colour: offwhite
Outside Border thickness: 0.3cm
Fabric: 65% polyester, 35% ripstop

42. VOCATION PATCH – RP

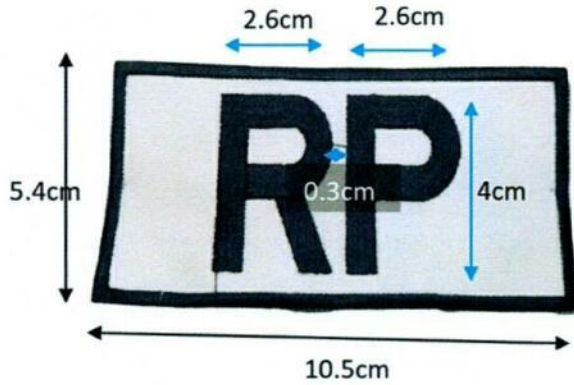

Border and patch design colour: black
Background colour: offwhite
Outside Border thickness: 0.3cm
Fabric: 65% polyester, 35% ripstop

43. VOCATION PATCH – PTI



Border and patch design colour: black
Background colour: offwhite
Outside Border thickness: 0.3cm
Fabric: 65% polyester, 35% ripstop

44. VOCATION PATCH – COXSWAIN

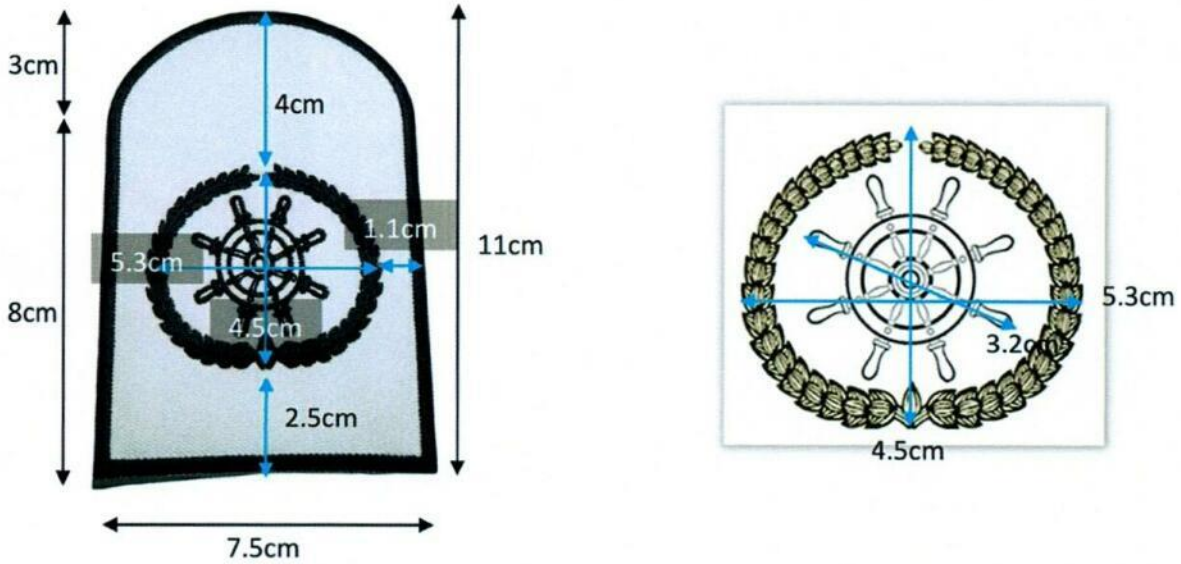

Border and patch design colour: black
Background colour: offwhite
Outside Border thickness: 0.3cm
Fabric: 65% polyester, 35% ripstop

45. VOCATION PATCH - BOATSWAIN'S MATE

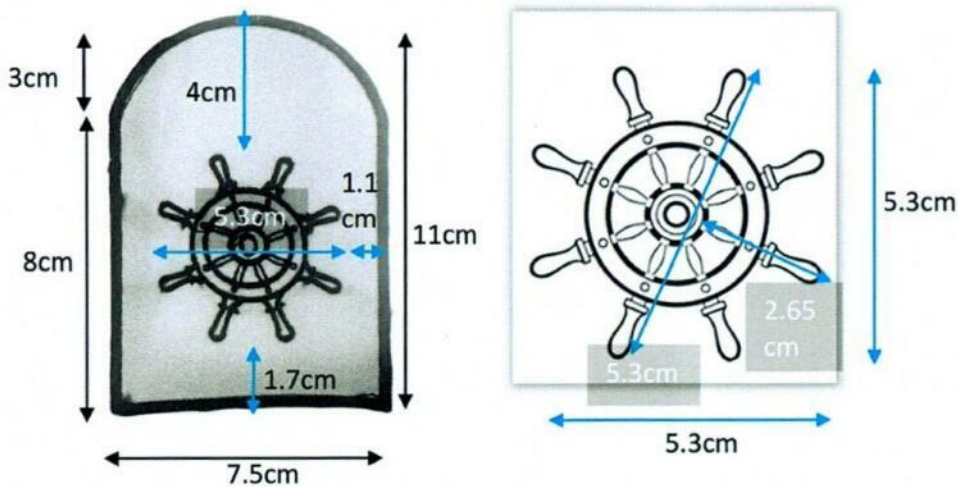

Border and patch design colour: black
Background colour: offwhite
Outside Border thickness: 0.3cm
Fabric: 65% polyester, 35% ripstop

46. VOCATION PATCH – NAVIGATION

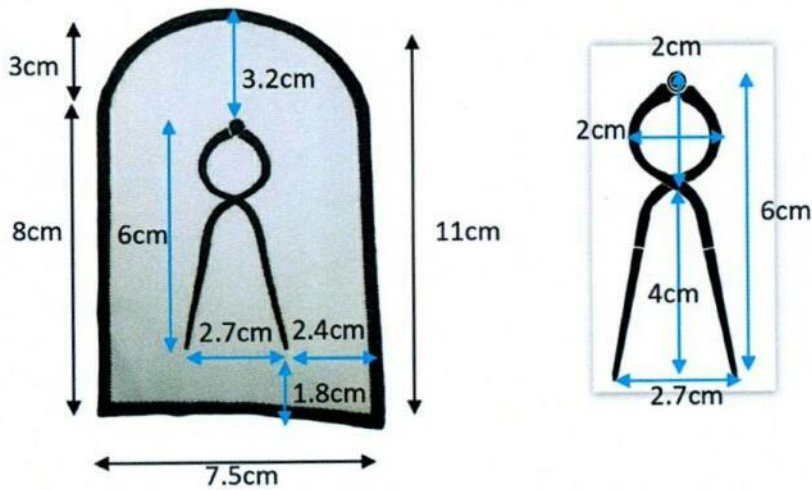

Border and patch design colour: black
Background colour: offwhite
Outside Border thickness: 0.3cm
Fabric: 65% polyester, 35% ripstop

47. VOCATION PATCH – COMMUNICATION

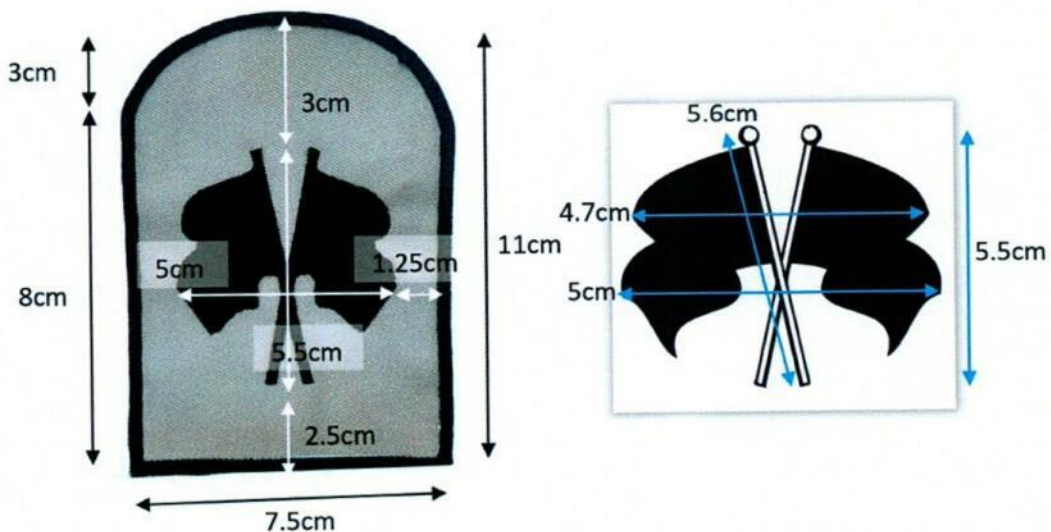

Border and patch design colour: black
Background colour: offwhite
Outside Border thickness: 0.3cm
Fabric: 65% polyester, 35% ripstop

48. VOCATION PATCH - ELECTRONIC WARFARE

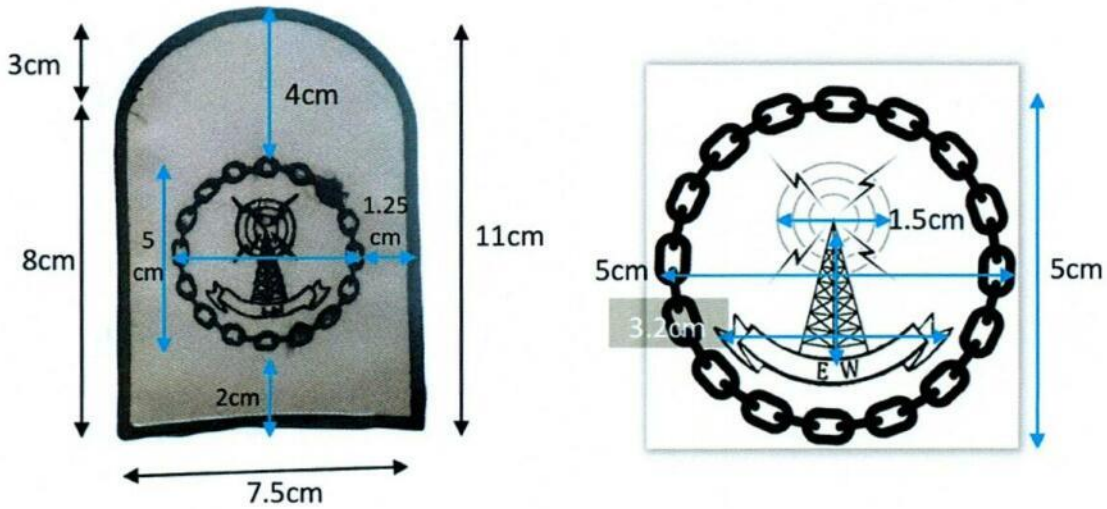

Border and patch design colour: black
Background colour: offwhite
Outside Border thickness: 0.3cm
Fabric: 65% polyester, 35% ripstop

49. VOCATION PATCH - ABOVE WATER WARFARE

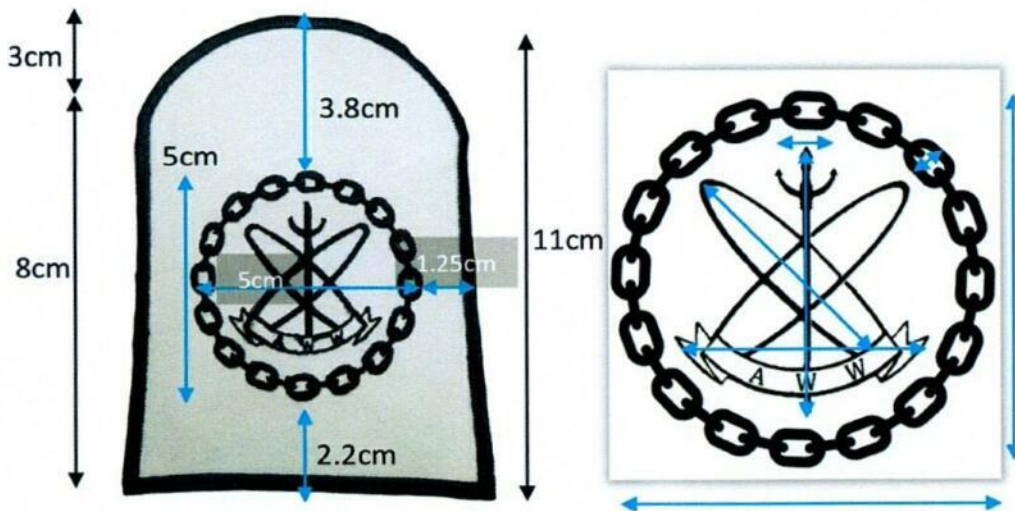

Border and patch design colour: black
Background colour: offwhite
Outside Border thickness: 0.3cm
Fabric: 65% polyester, 35% ripstop

50. VOCATION PATCH - ABOVE WATER TACTICAL

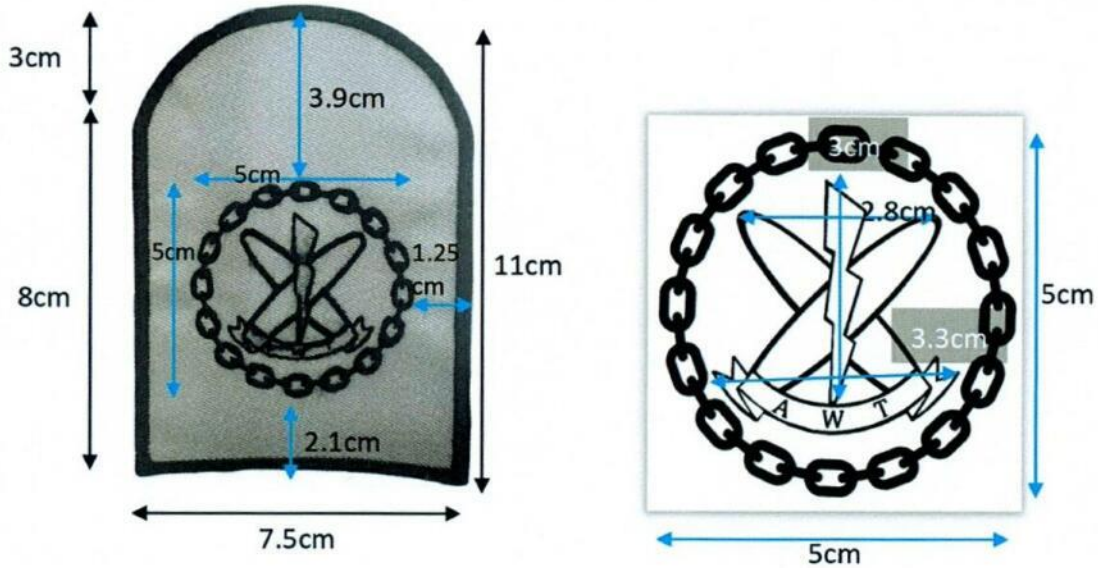

Border and patch design colour: black
Background colour: offwhite
Outside Border thickness: 0.3cm
Fabric: 65% polyester, 35% ripstop

51. VOCATION PATCH - MARINE TECHNICIAN

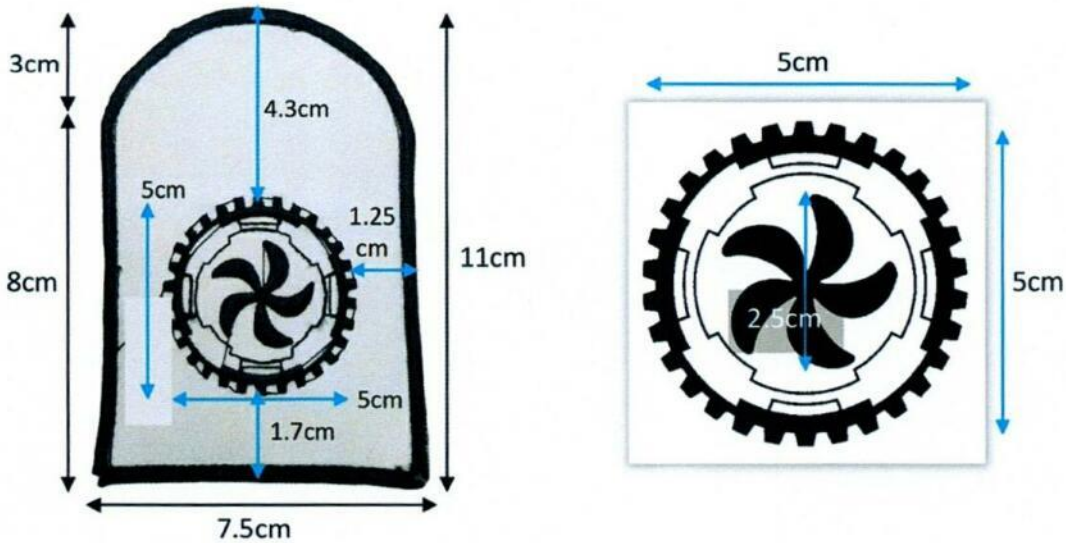

Border and patch design colour: black
Background colour: offwhite
Outside Border thickness: 0.3cm
Fabric: 65% polyester, 35% ripstop

52. VOCATION PATCH - WEAPON TECHNICIAN

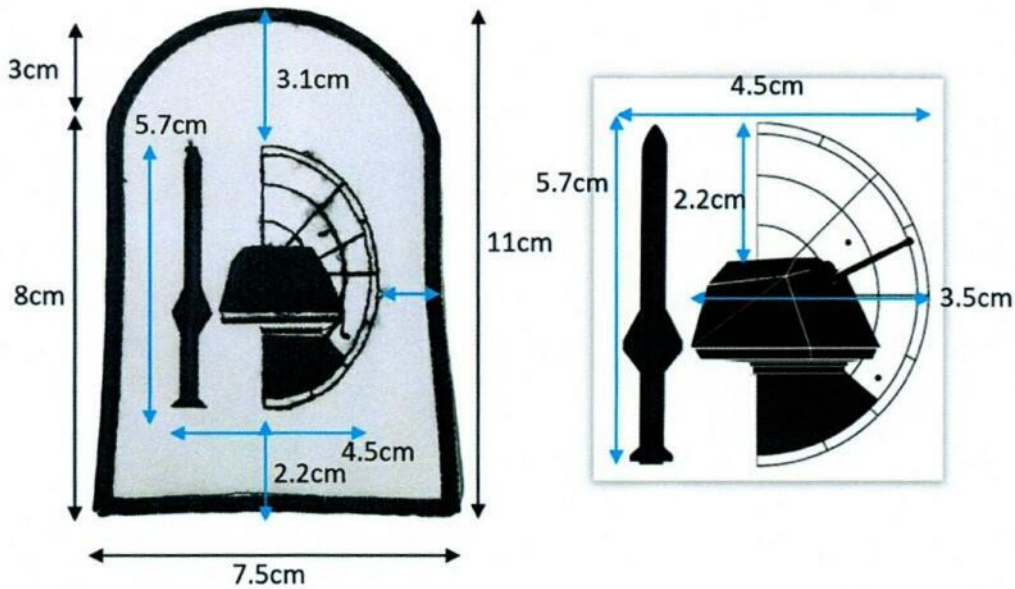

Border and patch design colour: black
Background colour: offwhite
Outside Border thickness: 0.3cm
Fabric: 65% polyester, 35% ripstop

53. VOCATION PATCH - NAVSAG (DIVING)

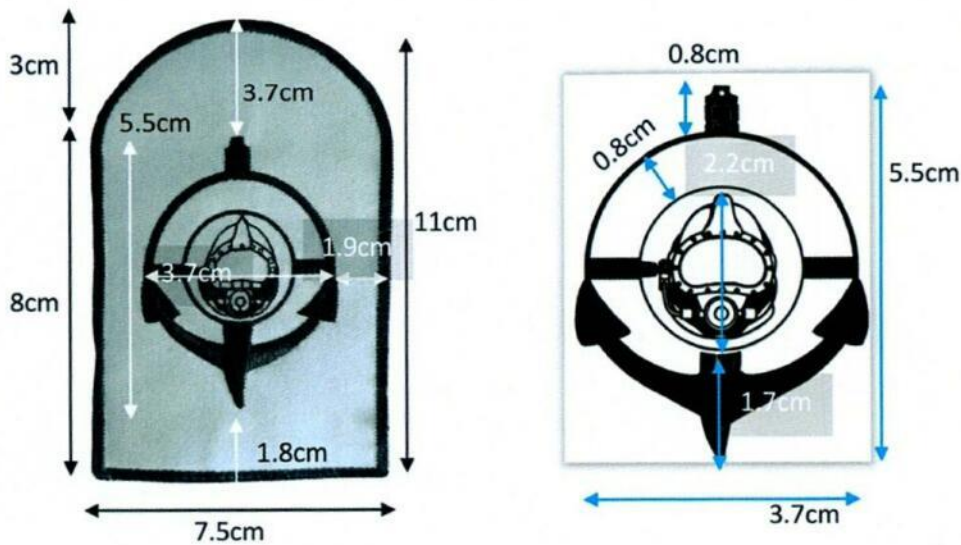

Border and patch design colour: black
Background colour: offwhite
Outside Border thickness: 0.3cm
Fabric: 65% polyester, 35% ripstop